



STC-WD2-IR
User's Manual



Toll Free Customer Support 1-877-269-8490
www.stealthcam.net

STC-WD2-IR

For Customer Service or Warranty Information Call Toll Free

877-269-8490

Stealth Cam, LLC

P.O. Box 535189

Grand Prairie, Texas 75053-5189

www.stealthcam.net

Stealth Cam Limited Warranty

Your Stealth Cam is covered by a One Year Limited Warranty on parts & labor from the date of purchase. The warranty covers defects in workmanship & materials. The warranty does not apply to units, which have been damaged or abused intentionally or unintentionally.

Tampering with or altering the unit will void the warranty. Any unauthorized service will void warranty. Original sales receipt must be produced for any warranty service. Questions call 877-269-8490

www.stealthcam.net Toll Free 877-269-8490

Manual Contents

Camera overview	4
Camera kit contents	8
Battery and memory Installation	9
Set up and programming	12
Camera use	20
Mounting the camera	21
Viewing & Deleting images	27
Memory compatibility chart	36
Technical Specs	37
General Information	40

Camera overview

Front housing image with major parts indication.

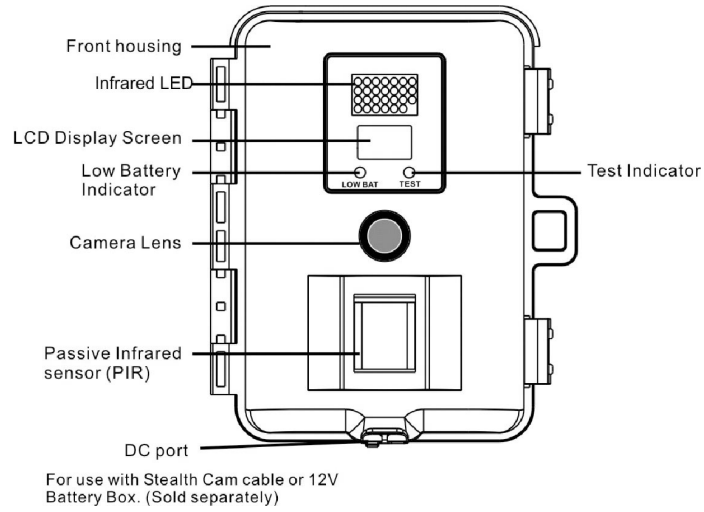

STC-WD2-IR

Open view image with major parts indication

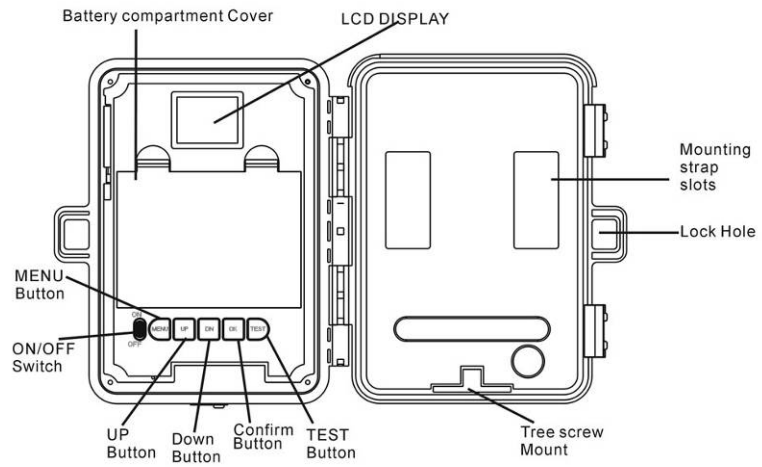

STC-WD2-IR

Side view with major parts indication

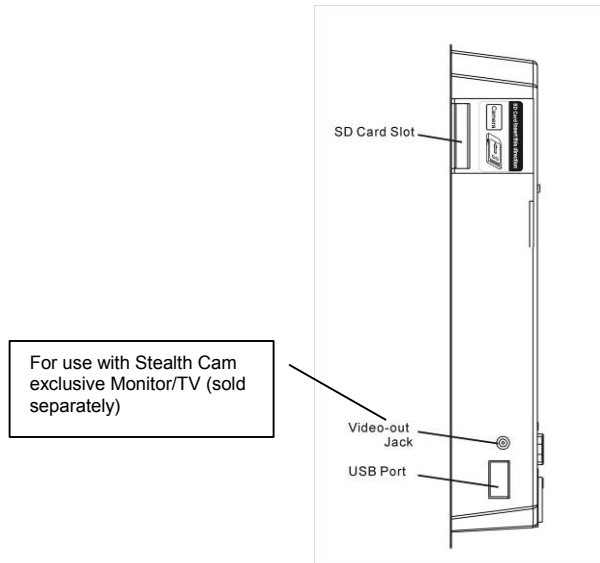

STC-WD2-IR

Image Capacity Chart

SD card	High	Low	Base	AVI
16MB	52	80	160	16
32MB	104	160	320	32
64MB	208	320	640	64
128MB	416	640	1280	128
256MB	832	1280	2560	256
512MB	1664	2560	5120	512
1GB*	3328	5120	10240	1024
2GB*	6656	10240	20480	2048

* Subject to card compatibility under different brand

NOTE: Picture / Image Capacity Chart provides approximate number of images or AVI movies based on resolution setting and the size of memory card. These figures may vary depending on the amount of detail in the image.

Camera kit contents

- Model STC-WD2-IR Digital Security/Scouting Camera
- CDROM (Contains Ulead Photo Express 8 and camera driver)
- User Manual.
- USB cable.
- TV out cable for TV (RCA Jack).
- TV out cable for handheld TV (Mini Jack).
- Strap.

Battery & memory installation

Warning: Do not use different Voltage lead acid battery other than the one specified in this section. Doing so will damage the camera and will void the warranty.

The Stealth Cam STC-WD2-IR Advanced Digital Security/Scouting Camera is designed to operate using two different types of battery power options.

NOTE: Always have camera in OFF position when installing or removing batteries.

Batteries “C” cell

The internal battery compartment accepts 6 “C” cell batteries. Be sure to use high quality brand name alkaline batteries. Install batteries in correct polarity (+/-) as noted inside battery compartment.

12V Lead Acid external battery

The STC-WD2-IR is equipped with an external power jack designed to accept a barrel plug cable to attach to a sealed lead acid battery. (Sold separately). Battery cable and complete 12V Lead Acid battery kits are available wherever Stealth Cam scouting cameras are sold or call toll free 877-269-8490. Only Stealth Cam external battery accessories are recommended.

- Make sure the camera power switch is OFF and power source switch on BATTERY.
- Insert the battery pack plug into the DC 12V jack of the bottom of camera housing
- Turn the camera power on.

❖ ***Please make sure the voltage and polarity (+/-) are correct before connection. Incorrect voltage or polarity (+/-) will damage the camera.***

Memory Options

Your STC-WD2-IR camera is equipped with 16MB built in flash memory. The camera is also equipped with an expendable media card slot capable accepting up to 2GB SD card (sold separately). With no memory card inserted into the slot, the camera will use the built in 16MB memory. If a SD card is inserted into the slot then the camera will bypass the built in memory and utilize the SD memory. The front counter display will show the number of images on the built in memory unless the expansion card is inserted at which point the counter will only show the number of images in the expansion card.

Inserting SD card

Make sure camera is in the OFF position whenever adding or removing memory.

- Insert SD memory card in to the SD card slot completely and in the correct direction as shown by the sticker located at the side of the housing.
- To remove the SD memory card, depress the SD card and pull

out the card gently.

- ❖ ***SD cards must be clean (no images from other sources), if you are using the SD card from other cameras, please make sure to format the SD card prior use in the STC-WD2-IR (See format section on page 18). New cards are good to use straight from the package.***

Set up and Programming

When the camera is first turned on the internal LCD screen displays the camera status. The following information is present on this screen.





If no buttons are pressed after 30 seconds the LCD screen will power down to conserve battery life and enter 1 minute count down to enter PIR detection mode. To re-power the display screen press and hold the UP or DOWN button for at least 5 seconds.

Definition

- **Time out:** To set the amount of time in minutes the camera will sleep between PIR triggering.
- **Infrared LED:** In low light conditions the infrared emitter will automatically activate.
- **Capture mode:** The capture mode that you have selected.
 - **1P:** Single image capturing per PIR triggering.
 - **2P:** Two images continuous capturing per PIR triggering.
 - **3P:** Three images continuous capturing per PIR triggering.
 - **Video:** Taking 10 seconds video per PIR triggering.
- **Resolution:** The resolution selection that you have selected.
 - **High (1600 x 1200):** Select this option to capture a 2.0M pixels image. (High image quality)
 - **Med (1280 x 960):** Select this option to capture a 1.2M pixels image. (Medium image quality)
 - **Base (640 x 480):** Select this option to capture a 0.3M

STC-WD2-IR

pixels image. (Low image quality)

- **Video resolution (320 x 240):** This is the resolution during video capturing.
- **Batteries Status:** It shows the battery status.
 - **Full:** It shows the batteries are full. 
 - **Half:** It shows the batteries are half. 
 - **Low:** It shows the batteries are low and front low battery indicator will also be lit.  Blinking
- ❖ ***When the camera has detected low batteries, (Batteries are lower then 6.6 +/-0.2Volts) the camera unit will power off within 30 seconds automatically. Please replace with new batteries; otherwise the camera will not work properly.***
- **Day and Time:** It shows the **date and time that you have set.**

Programming the Stealth Cam STC-WD2-IR





Switch the camera to the ON position. LCD screen will show "ON" for few seconds and then display the camera status screen. Press the **MENU** button within 30 seconds to enter programming mode. This will bring up the SETTING screen.

If **MENU** button is not pressed within 30 seconds, camera will automatically enter PIR detection mode.

Set the Resolution: The first program setting is resolution. To the right of Resolution, the word HIGH will be blinking

- Press [OK] button to choose the selection
- Press the [UP] or [DN] button to select the desired resolution (HIGH/MED/BASE) and press [OK] to save and exit to CAPTURING setting

Set the Capturing sequence. *The Stealth Cam STC-WD2-IR can be programmed to shoot 1-3 pictures per triggering or 10 seconds of video.*

- This icon will be blinking 
- Press [OK] button to choose the selection
- Press the [UP] or [DN] button to select the desired capture setting (number of pictures per triggering).
1picture / 2 pictures / 3 pictures    or Video
- Press [OK] to save and exit to TIME OUT setting.

Set the Time out:

- The word TIME OUT and Digit will be blinking 
- Press [OK] button to choose the selection
- Press [UP] or [DN] button to increase or decrease the time value in minutes from 01 to 59 minutes.
- Press [OK] to save the setting and exit to Date & Time setting.

Set Date and Time: This camera uses the 24hr military time format.



- The word TIME and minute digit will be blinking.
- Press [OK] to choose the selection
- Press [UP] or [DN] to increase or decrease the minute value (01 – 59)
- Press [OK] to confirm the minute setting and enter hours setting {HH (Hour) will be blinking}
- Press [UP] or [DN] to increase or decrease the hour value (01 – 24)
- Press [OK] to confirm the hour setting and enter month setting {MM (Month) will be blinking}
- Press [UP] or [DN] to increase or decrease the month value. (01 – 12)
- Press [OK] to confirm the month setting and enter date setting {DD (Date) will be blinking}
- Press [UP] or [DN] to increase or decrease the date value.

STC-WD2-IR

(01 – 31)

- Press [OK] to confirm the date setting and enter year setting {YY (Year) will be blinking}
- Press [UP] or [DN] to increase or decrease the year value. (04 – 99)
- Press [OK] to confirm the year setting and exit to delete setting.

Delete / Format setting

- The word FORMAT will be blinking.
- Press [OK] to choose the selection
- Press [OK] the second time to format the memory (if SD memory card is inside the card slot, it will format the SD memory card.
- Or press [UP] or [DN] to select DELETE ONE (d-ONE) or DELETE ALL (d-ALL) or NO DELETE (NO-dL) or FORMAT (FORMAT blinking)

STC-WD2-IR



- Press [OK] to confirm and exit to RESOLUTION setting
- If you choose Delete One or Delete All, you will remain in this mode until you press [DN] button to move the selection to No Delete then press [OK] to exit to Resolution setting.
- Press [MENU] to exit to power on status.

Once all settings have been completed press the [MENU] button to return to CAMERA STATUS screen.

At the end of each program set up selection, you may press [MENU] to exit and return to camera status ready for the 1 minute count down mode to enter PIR capturing.

Using the camera

Once all program setting has been completed your Stealth Cam is ready for field use.

Getting started

Mounting the Camera. It is recommended to mount the camera 4-5 ft off the ground with the camera pointed at a slight downward angle. Be sure to avoid mounting the camera facing east or west as the rising and setting of the sun could produce false triggers and overexposed images. Clear branches and other debris away from the front of the camera so as not to block the camera lens or PIR sensor.

PIR Coverage Area
Diagram

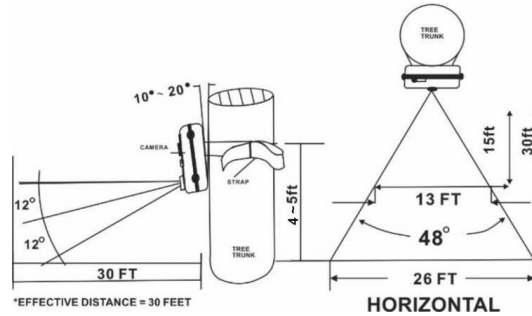

www.stealthcam.net Toll Free 877-269-8490

Mounting the camera

Mounting the camera with Tree Screw (Optional Accessory sold separately)

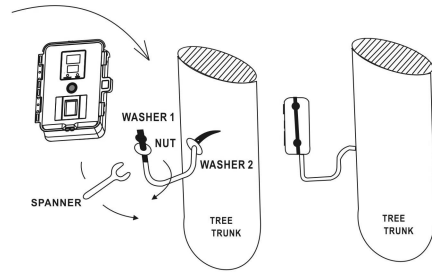

- Hand twist the screw into the tree or post at the desired position.
- Attached the camera to the screw by turning the camera onto the mounting screw to the desired position.
- Tighten the stabilizer nut.

- ❖ **Attached camera to tree screw. Do not over tighten as this may cause damage to camera housing. Using the supplied nut and washer, tighten to the bottom of camera for greater stability.**

Mounting the camera with the supplied strap

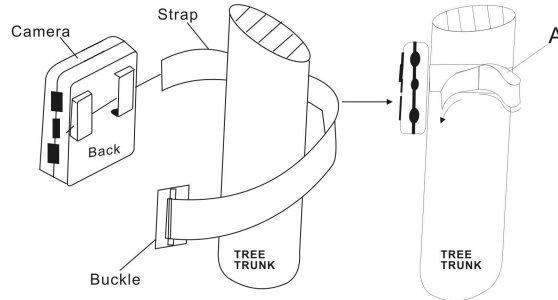

- Insert the strap through the strap slots on the rear housing.
- Wrap the strap around the mounting surface. Secure the strap and tighten the buckle in order to secure the camera.

Stealth Cam offers a Security Lock Bracket for uses exclusively with this camera. See included accessory card or call toll free 877-269-8490.

- ❖ ***In order to obtain proper weather resistance, please make sure that both door latches are securely locked in place.***

Testing the camera coverage area

One of STC-WD2-IR Cam's many features is the ability to test the coverage area.

- After mounting the camera, open front housing and slide the power to ON.
- After the front LCD screen has powered on. Press the [TEST] button (this must be done within 30 seconds or the camera will enter count down mode)
- Close the front housing.
- Walk around in the front of the camera to see if you have

STC-WD2-IR

mounted camera in the proper position. A green indicator light on the front will blink on when you have intruded the coverage area.

- Adjust the camera position as needed and repeat testing until the desired coverage area is achieved.
- When you have completed the testing the coverage area there are 2 methods for exiting the test mode:
 - a. Open the front housing and press the [TEST] button to exit test mode. The camera will then enter count down mode for 1 minute and front green indicator will start blinking giving you one minute to leave the coverage area. Then the camera will enter PIR detection mode.
 - b. After 5 minutes in test mode, the camera will then enter count down mode for 1 minutes and the front green indicator will start blinking giving you one minute to leave the coverage area. The camera will enter PIR detection mode.

Using the camera in PIR detection mode

- Mount the camera to tree or other sturdy object using either supplied tree screw or mounting strap (Please refer to the mounting suggestions section in this manual)
 - Open the front housing and move the switch to the ON position. At this point you have 30 seconds to make any program adjustments.
 - After 30 seconds the camera's green test light will begin blinking and enter count down mode. This is your indication to leave the coverage area with one minute.
 - After one minute the camera will take between 1~3 pictures or a 10 seconds AVI video based on your program setting. The camera will then time out between 1 ~ 60 minutes also based on your setting.
- ❖ ***The time between motion detection and the camera taking the pictures may vary due to lighting conditions, program setting and battery power level.***

- ❖ *The IR LED will only activate in low light conditions.*
- ❖ *When using the AVI function, Time/Date stamp will not appear on the AVI video clips.*

Viewing and deleting the images

The STC-WD2-IR cam offers the user three different options for viewing the images. The external LCD display screen on the front housing will show the number of images in memory.

To wake the camera from PIR detection mode press and hold either the [UP] or [DN] button for about 5 seconds.

The instructions below are based on starting from a camera that is turned off.

Viewing the image on a handheld LCD TV video monitor (cable included)

- Attach the appropriate cable to the video out jack on the camera. Insert the other end into the video in jack on handheld LCD TV monitor. Turn on both the camera and TV monitor.
- A thumbnail view of the images in memory will be displayed on the TV screen.
- Press [MENU] button to set TV System.

STC-WD2-IR

- Press [OK] button to choose the setting.
- Press [UP] or [DN] to select TV system. TV-N (TV out in NTSC System). TV-P (TV out in PAL System)

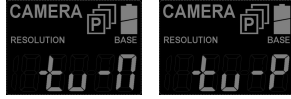

- Press [OK] to confirm setting.
- Press [MENU] to exist to power on status to continue with your image viewing.
- Using the [UP] and [DN] buttons select the image you wish to view.
- Press [OK] button to bring up the whole image on the screen.
- You may use the [UP] and [DN] buttons at this point to navigate though all the images in memory.
- To return to the thumbnail view from the full size image press the [OK] button.

Viewing the images on your home TV equipped with an RCA input jack (cable included)

- Attach the appropriate cable to the video out jack on the camera. Insert the other end into the RCA video in jack on the TV. Turn on both the camera and TV. Make **sure to switch to VIDEO IN mode on your TV. (See your TV owner's manual for directions.**
- Attach the appropriate cable to the video out jack on the camera. Insert the other end into the video in jack on handheld LCD TV monitor. Turn on both the camera and TV monitor.
- A thumbnail view of the images in memory will be displayed on the TV screen.
- Press [MENU] button to set TV System.
- Press [OK] button to choose the setting.
- Press [UP] or [DN] to select TV system. TV-N (TV out in NTSC System). TV-P (TV out in PAL System)

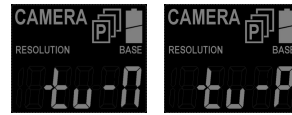

STC-WD2-IR

- Press [OK] to confirm setting.
- Press [MENU] to exist to power on status to continue with your image viewing.
- Using the [UP] and [DN] buttons select the image you wish to view.
- Press [OK] button to bring up the whole image on the screen.
- You may use the [UP] and [DN] buttons at this point to navigate though all the images in memory.
- To return to the thumbnail view from the full size image press the [OK] button.

Viewing AVI Clip on hand held TV monitor or home TV

- Follow the cable attaching instruction listed in hand held TV monitor or home TV described in previous section.
- Monitor will display a thumbnail image in the memory.
- Press [UP] or [DN] button to choose the AVI clip that you would

STC-WD2-IR

like to see.

- Press the [OK] button to play back the AVI motion clip.
- To return to thumbnail image selection view, press [OK] button at the end of the AVI clip.

Viewing images by computer download

The Stealth Cam STC-WD2-IR Digital Scouting Camera is a plug and play USB storage device. This means users of Windows 2000 / ME / and XP operating system need not install the camera driver. This camera is not MAC compatible. The disc included in this package contains the camera driver for older operating systems as well as Ulead Photo Explorer imaging software for image enhancement and manipulation.

Attention:

The software CD-ROM packaged with the camera is designed for PC's only (not MAC compatible). Playing this CD-ROM on a stereo or CD player may cause damage to it.

Software installation

- Unplug the USB cable from PC.
- Insert the CDROM in CD driver of your PC.
- The auto-run program will execute.
- Follow the instructions shown on screen from your PC to completely install the driver and application program.
- Restart windows.
- Successful installation will create "Ulead Photo Explorer" icon on you desktop.
- Connect your camera to the PC by the USB cable, the PC will recognize the new device and set UP the configuration of the PC automatically.

STC-WD2-IR

NOTE: Users of Windows 98 or earlier must install camera driver prior to connecting the USB cable.

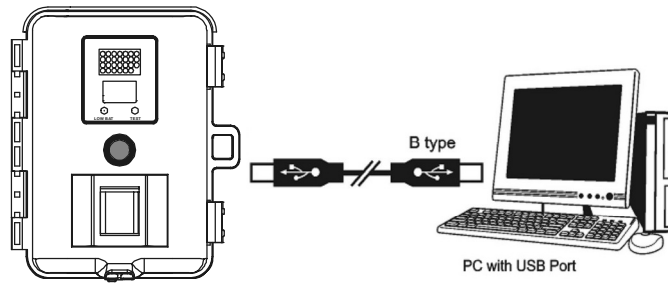

- If your computer doesn't run automatically, please click "Start" button and choose "Run", and then browse the CD drive and click "Setup".
- Operation manual of Ulead Photo Explorer is contained on the provided CDROM.

Viewing the images on your computer using the provided software

Please refer to Installation section on above to install the software and application program properly.

- Slide the power switch to OFF location.
- To view the images simply plug one end of the USB cable into an available USB port on your computer.
- Plug the other end of USB cable into the camera. The camera will automatically power ON and display a USB icon on the LCD screen.



- At the same time, your computer will recognize the camera as mass storage device and found under MY COMPUTER.

Deleting images

At any time while viewing images on Handheld TV or Home TV you may delete images one at a time or all at once.

STC-WD2-IR

- While viewing images either in thumbnail view or full screen press [MENU] once and press [DN] button to enter the DELETE & FORMAT menu.
- Press [OK] button to confirm setting
- Using the [UP] and [DN] buttons to the desired function. No Delete (NO-dL), Delete one (d-ONE), or Delete ALL (d-ALL).



- If you chose to delete one picture, it will delete the picture that you selected on the Thumbnail view or the image that is on full screen.
- If you choose Delete One or Delete All, you will remain in this mode until you press [DN] button to move the selection to No Delete then press [OK] to exit to Resolution setting.
- Press [MENU] to exit to power on status.

SD Memory Card Compatibility Chart

The following cards have been tested and approved for use in the STC-WD2-IR model.

PQI	32MB, 64MB, 128MB, 256MB, 512MB
San Disk	32MB, 64MB, 128MB, 512MB, 1GB
Panasonic	32MB, 64MB, 256MB, 512MB
Toshiba	32MB, 64MB, 128MB, 256MB, 512MB
King Mate	32MB, 64MB, 128MB, 256MB, 512MB
Lexar	32MB, 512MB
Kingston	128MB, 256MB, 512MB
Kodak	128MB, 256MB, 512MB
Dan-Elec	128MB, 256MB, 512MB
PNY	128MB, 256MB, 512MB

Proper camera operation cannot be guaranteed when using memory card **NOT** listed above.

Technical Specifications

System Requirements and Compatibility

- Windows 98/98se/2000/Me/XP
 - Pentium 450MHz or equivalent processor
 - 128MB SDRAM or above
 - VGA Video Card with 32MB RAM for minimum, Color 16 bit or higher
 - An available CDROM driver and an available USB Port
 - 600 MB free hard disc space
 - Optional: Windows compatible sound card, Microphone and speaker
- ❖ ***If you have any questions regarding your PC specifications please call your PC manufacturer.***

Camera Features and Specification.

- Image sensor: 1.3 mega-pixels (2.0 mega-pixels interpolation)
- Built in 1.8" B&W LCD display
- Built in 16M flash memories for image storage
- External memory support: SD memory card up to 2.0GB
- Resolution Options: Hi (2.0M), Base (1.2M), VGA (0.3M)
- 3 Capturing Options: Single, Continuous, AVI
- Image performance for video stream: 10fps in 320 x 240 pixels, approx 10 seconds per section
- Auto white balance and auto expose
- Auto IR emitter light control
 - ◆ Effective Range for Still picture (up to 30 ft)
 - ◆ Effective Range for AVI clip (up to 16ft)
- Real time clock for date and time stamping
- 4 digits LCD Image counter

www.stealthcam.net Toll Free 877-269-8490

STC-WD2-IR

- Battery low indicator
- Green Test LED indicator
- TV out support for NTSC and PAL system
- Focusing: 5 ft to Infinity
- High precision 4 P glass lens with coating.
- Effective viewing Angle: 52 deg.
- PIR detection angle 48 deg.
- Low power consumption:
 - ◆ Standby current: < 1mA.
 - ◆ Capture current <150mA
- Interface type: USB 1.0
- Power: C size alkaline Batteries x 6
- External power: 12 volts battery pack
- Image format: Standard JPEG. And Motion JPEG (AVI)

General Information

Storing conditions

- Operating Environment: 14 to 104 deg F (-10 to 40 deg C). 20-85% relative humidity, non-condensing.

Special care instructions!!

- The camera is designed to be weather resistant. Never attempt to immerse the unit to water or any other liquid. This will damage the unit and void the warranty.
- Use a soft lens cloth for cleaning lens. Avoid touching lens with fingers.
- Remove dirt or stains with a soft cloth dampened with water or neutral detergent. Keep the STC-WD2-IR cam in a dry and cool dust-free environment or container when it is NOT used.
- Take the batteries out, when the STC-WD2-IR cam is NOT to be used over a long period.
- Avoid dropping the STC-WD2-IR cam on to hard ground. Do not disassemble the STC-WD2-IR cam.

STC-WD2-IR

- Do not mix new and old batteries.
- Do not open the camera for unauthorized service. This could cause serious damage to the unit and will void the warranty.

This camera is a precision electronic device. Do not attempt to service this camera yourself, as opening or removing covers may expose you to dangerous voltage points or other risks.

WF031E_R1 Print In China

www.stealthcam.net Toll Free 877-269-8490

41